



LA-2835WWWWWWWW

规格书

Specification

型号/Part Number: LA-2835WWWWWW-WW

产品/Product: 2835 0.2W 3V 60mA 单晶 暖白

编号/Serial number: 样品编号

发行日期/Issue Date: 出样日期

两岸光电审核 Banq approva			客户审核 Client approval	
核准 Approval	确认 Audit	制作 Confirmation	核准 Approval	确认 Audit
			接受 <input type="checkbox"/> Qualified	不接受 <input type="checkbox"/> Disqualified
原因/ Reason:				



LA-2835WWWWWWWWW

● 目录: (Content)

◆ 封面: (Cover)	-----	PAGE: 1 OF 12
◆ 产品简介 (Product introduction)	-----	PAGE: 2 OF 12
◆ 外形尺寸图 (Outline Dimensions)	-----	PAGE: 3 OF 12
◆ 产品编码解说及光电参数 : Electrical-Optical Characteristics	-----	PAGE: 3-4 OF 12
◆ 色区分 BIN 及色温坐标 : (Intensity Bin Limit)	-----	PAGE: 5 OF 12
◆ 光电特性曲线图 : (Optical Characteristics)	-----	PAGE: 7 OF 12
◆ 信赖度测试项目及标准: (Test items and results of reliability)	-----	PAGE: 8 OF 12
◆ 包装规范 : (Packing)	-----	PAGE: 9 OF 12
◆ 产品使用说明及注意事项: (Usage and Handling Instructions)	-----	PAGE: 10-12 OF 12

● 特性: (Features)

- ◆ 3.5 长*2.8 宽*0.7 高 : (3.5mm*2.8mm *0.7mm SMT LED Thickness.)
- ◆ 角度: 120 度 : (View Anglc: 120°)
- ◆ 包装: 4000/一盒 : (Package: 4000PCS/Package)
- ◆ 晶片: 蓝光 (InGaN): (Dice:Blue(InGaN))
- ◆ 工作温度: -40~80 度 : (Operating Temperature:-40~+80°C)
- ◆ 焊接温度: 260 度 10 秒: (Soldering Temperature: 260for10sec°C)
- ◆ 超大功率 : (Supper High Power Consumption)
- ◆ 可做不同的种类: (Various Colors And Types Available.)
- ◆ 胶水: 硅胶 : (Resin(Mold):Silicone)
- ◆ 反向电压 5V : (Reverse Voltage:5V)
- ◆ 储存温度-40~+100 度 : (Storage Temperature:-40~+100°C)
- ◆ 脉冲电流 60mA 注: 脉冲宽度 0.1mS 占空比 1/10
Pulsed Forward Current 60mA (Duty 1/10, Pulse Width 0.1mS.)



LA-2835WWWWWWWWW

● 尺寸图 : (Outline Dimensions)

封装尺寸
Package Dimensions

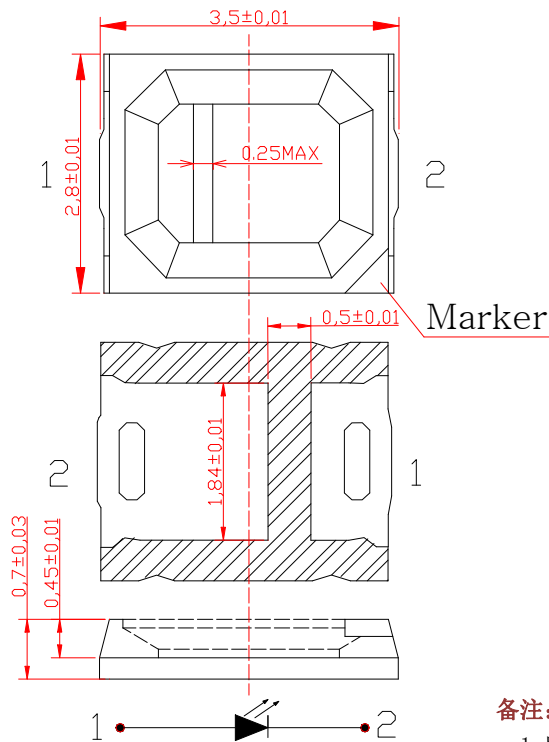

建议焊盘尺寸图
Recommended Soldering Pattern

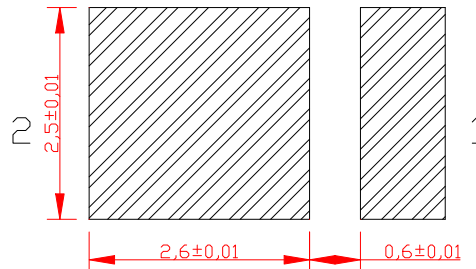

备注: (Notes:)

1. 所有标注尺寸单位为毫米
All dimension units are millimeters.
2. 除特别标注外, 所有尺寸允许公差±0.15mm
All dimension tolerance is ±0.15mm unless otherwise noted.

● 产品编码解说 : (Product Definition Code)

公司代码	成品颜色			测试电流					成品色温			
LA	2835	C	P	1	E	4	X	—	H01	C	—	A1
	产品类别	成品光通量	芯片数量	芯片波段 (白光)	芯片厂家代码	显色指数	胶水/电压					



LA-2835WWWWWWWWW

● **光电参数 (温度=25℃):** (Electrical-Optical Characteristics)

参数名称 Parameter	符号 Symbol	数值 Value			单位 Unit	测试条件 Test condition
		Min	Typ	Max		
正向电压 Forward Voltage	Vf	2.8	---	3.4	V	If=60mA
光通量 Luminous Flux	Φ	22		28	LM	If=60mA
色温 Color Temperature	CCT	3000		6000	K	If=60mA
显色指数 Color Rendering Index	CRI	80		83	---	If=60mA
光效 luminous efficacy of light source	φ	120		135	Lm/W	If=60mA
反向电流 Reverse Current	Ir	---	---	10	uA	Vr=5V
全视角 Viewing angle	2 θ 1/2	---	120	---	Deg	If=60mA
晶片节温 Junction temperature	Tj	---	---	110	℃	If=60mA
防静电 Antistatic ability	ESD	2000V				

● **最大限度值** (Absolute Maximum Ratigs) TA=25±5℃

项目 Item	符号 Symbol	最大额定值 Absolute Maximum Ratig	单位 Unit
正向电流 Forward Current	IF	60	mA
正向峰值电流 Pulse Forward Current	IFP	100	mA
反向电压 Rverse Voltage	VR	5	V
功率消耗 Power Dissipation	PD	0.2	W
工作温度 Operating Temperature	Topr	-40℃ TO +85℃	℃
贮藏温度 Storage Temperature	Tstf	-40℃ TO +85℃	℃
焊接温度 Soldering Temperature	Tsld	Roflow Soldering:260℃ Hand Soldering:350℃	For10sec for 3sec

备注[Note]:

- *光通量 (LM) ±10% Luminous intensity(LM) 10%
- *正向电压±0.05 Forward Voltage (VF)0.05V



LA-2835WWWWWWWWW

● **电压分级规格:** (Opto-Electrical Grading Specification)

电压等级 Voltage Grade	B	C	D	E	F
分级参数 Grade standard	2.8-3.0V	3.0-3.2V	3.2-3.4V	/	/

备注: [Note]:

*测试温度=25°C Test Temperature=25°C

*正向电流=60mA Forward current=60mA

● **X Y 轴分布(X/Y Rank)**

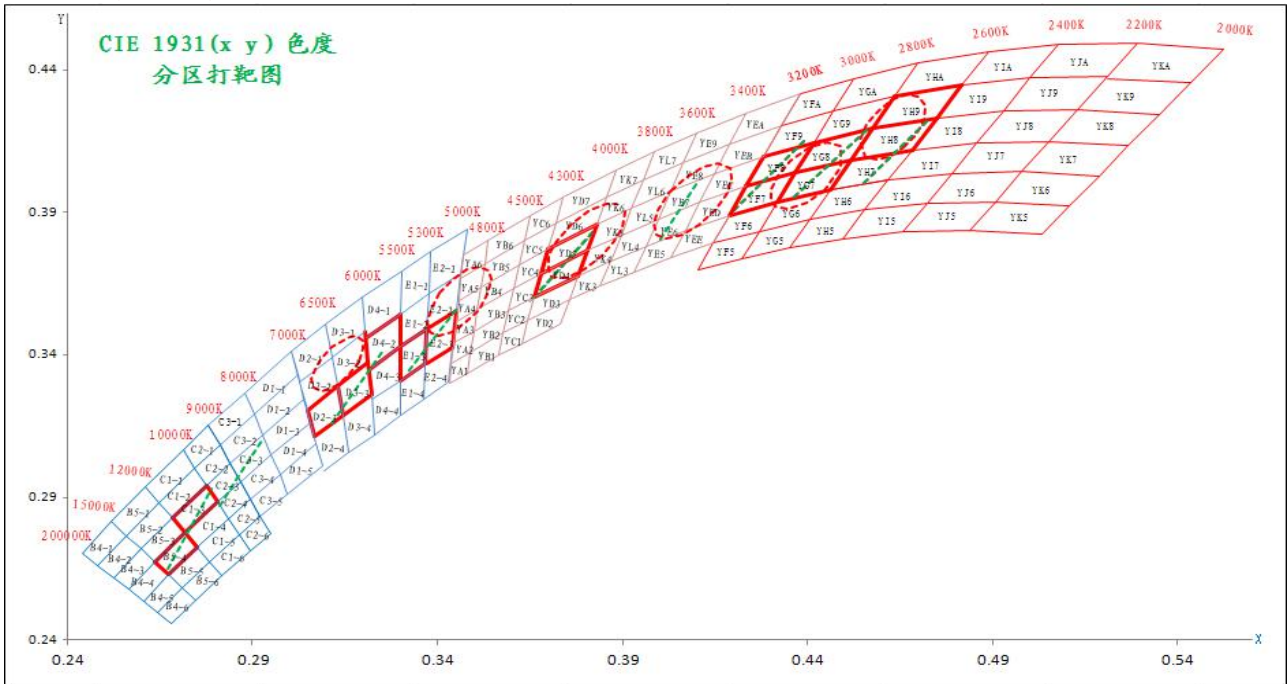

● **分BIN参数:** (Color Coordinate Comparison)

● 色坐标范围

Rank	Chromatocity Ranks		Rank	Chromatocity Ranks		Rank	Chromatocity Ranks		Rank	Chromatocity Ranks	
	x	y		x	y		x	y		x	y
27E	0.475	0.428	30E	0.428	0.3999	40E	0.368	0.376	50E	0.336	0.354
	0.46	0.407		0.434	0.3886		0.387	0.397		0.341	0.344
	0.452	0.412		0.447	0.4195		0.392	0.385		0.356	0.364
	0.464	0.434		0.4535	0.4091		0.372	0.363		0.352	0.375
65E	0.3085	0.3257									
	0.3046	0.3322									
	0.3175	0.3494									
	0.3213	0.3431									



LA-2835WWWWWWWWW

● 典型光学特性曲线: (Typical optical characteristics curves)

电压与电流关系曲线图

Forward Current VS Forward

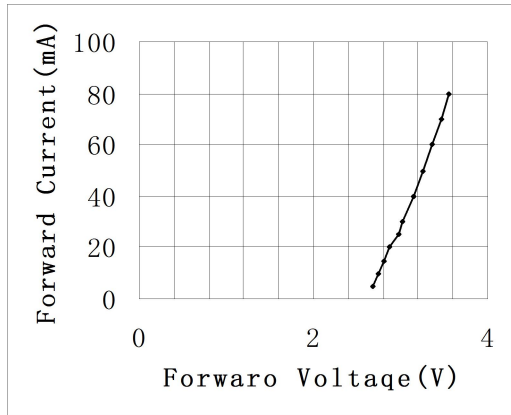

光通量与电流关系曲线图

Relative Luminous VS Current

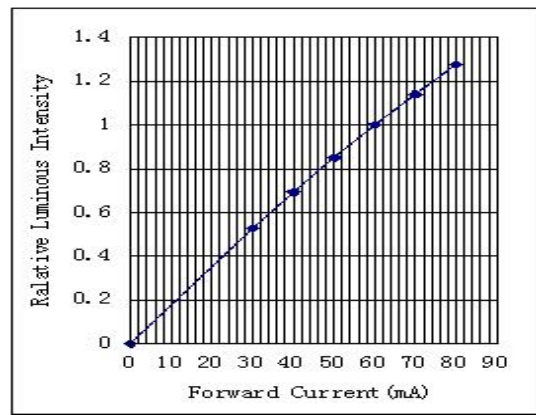

光通量与温度关系曲线图

Relative Luminous vs. Ambient Temperature

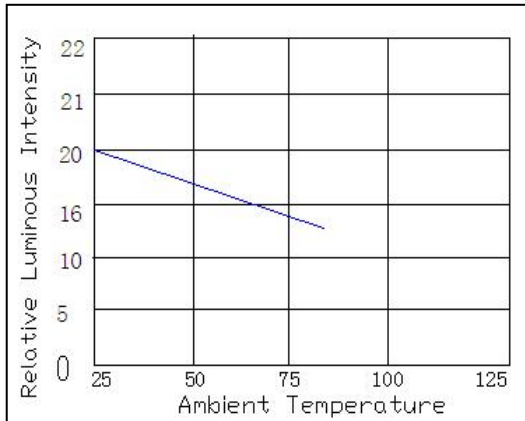

电流与温度关系曲线图

Forward Current IF-Ta

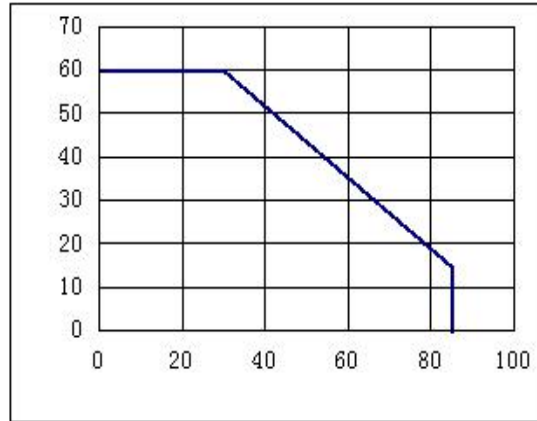

光谱特性图

Relative Spectral Distribution

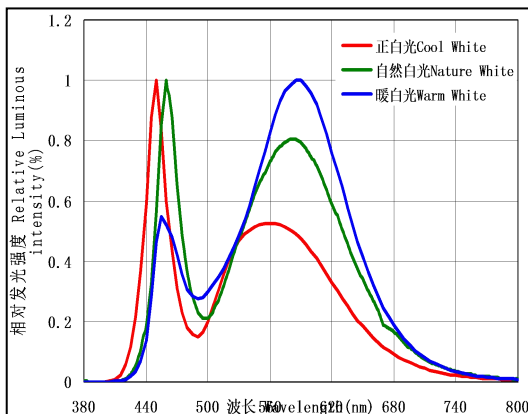

发光角度图 (极坐标)

Typical Spectral Distributio

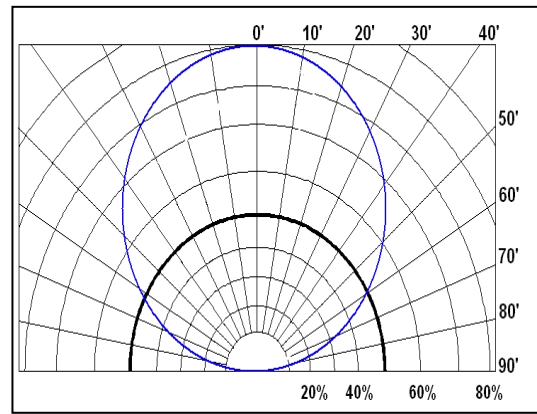



LA-2835WWWWWWWWW

● 信赖性测试项目及标准: (Test items and results of reliability)

测试项目 Test Item	测试条件 Test Conditions	持续周期 Duration/Cycle	破坏数量 Number of amage	参考 Reference
温度循环 Temperature	-40°C 30min ↑ ↓ 25°C (2min) 100°C 30min	循环 100 次	0/100	JEITA ED-4701 300 303
冷热冲击 Thermal Shock	-40°C 30min ↑ ↓ 5sec 110°C 30min	循环 100 次	0/100	JEITA ED-4701 200 303
高温储存 High Temperature Storage	Ta=100°C	1000 小时	0/100	EIAJED-4701 200 201
高温高湿 Humidity Heat Storage	Ta=85°C RH=85%	1000 小时	0/100	EIAJED-4701 100 103
低温储存 Low Temperatue Storage	Ta=-40°C	1000 小时	0/100	EIAJED-4701 200 202
常温老化 Life Test	Ta=25°C IF=60mA	1000 小时	0/100	Tested with Runlite standard
高温高湿老化 High Humidity Heat Life Test	60°C RH=90% IF=60mA	1000 小时	0/100	Tested with Runlite standard
低温老化 Low Temperature Life Test	Ta=-40°C IF=60mA	1000 小时	0/100	Tested with Runlite standard
静电放电人体模式 ESD (HBM)	1KV at 1.5KΩ ; 100pF	3 次	0/100	MIL-STD-883D

● 失效判断标准: (Criteria for judging the Damage)

项目 Item	符号 Symbol	条件 Condition	失效判断标准 Criteria for Judgement	
			下限 MIN	上限 MAX
顺向电压 Forward Voltage	VF	IF=60mA	---	USL*1×1.1
反向电流 Reverse Current	IR	VR=5V	---	10uA
发光强度 Luminous Intensity	Iv	IF=60mA	LSL*2×0.7	---

备注: [Note]:

*USL: 标准上限值

U.S.L: Upper standard level

*LSL: 标准下限值

Lower Specification Level



LA-2835WWWWWWWWW

● 包装规格

◇ 标签: (Label)

卷轴尺寸: (Reel Dimensions)

Part No: LA-XXXXXXXXXX-XXXX-XX					
IV	code	Min	Typ	Max	std
XY					
VY					
RA					
Qty					

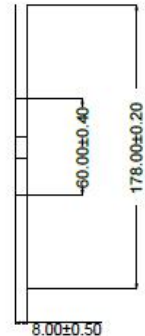
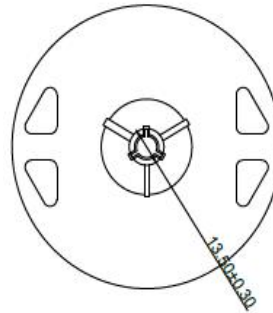

◇ 载带规格 (单位: mm): (Tape Specifications (Units : mm))

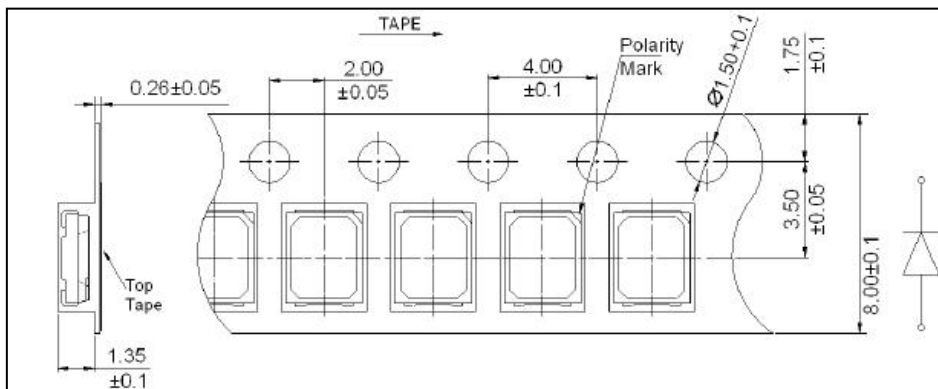

◇ 防潮带包装: (Moisture Resistant Packaging)

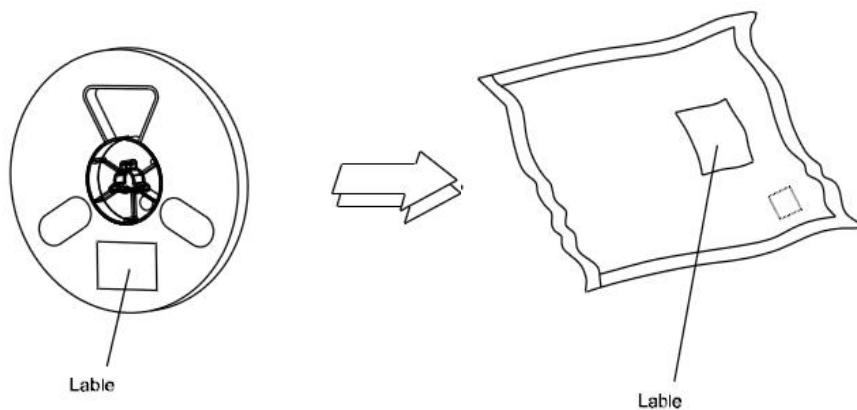

注: 标注公差为±0.1mm, 单位: mm : (Note: The tolerances unless mentioned is ±0.1mm, Unit: mm)



LA-2835WWWWWWWWW

● 回流焊接曲线图 (IR reflow soldering Profile)

◇ 有铅焊接 (Lead solder)

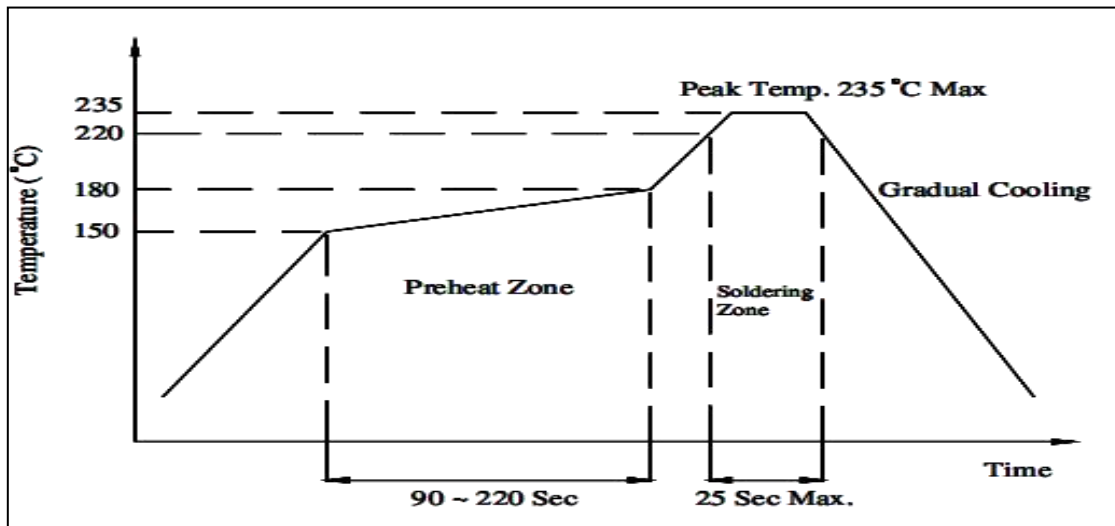

◇ 无铅焊接 (Lead Free solder)

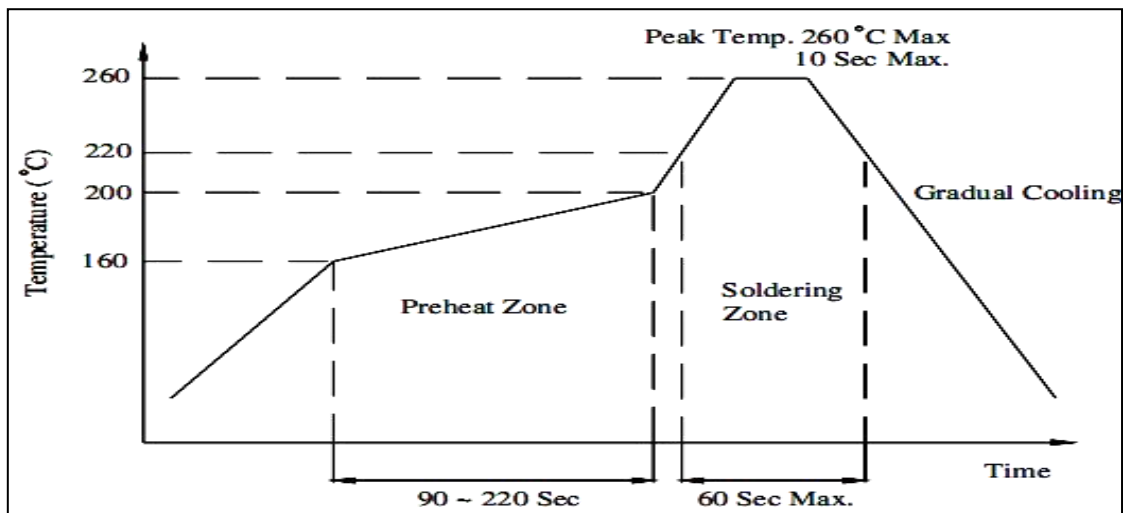

注意: (NOTES:)

1. 我们建议的回流焊温度为 $240^{\circ}\text{C} \pm 5^{\circ}\text{C}$ ，最高的焊接温度要控制在 260°C 以内。
We recommend the reflow temperature $240^{\circ}\text{C} \pm 5^{\circ}\text{C}$. the maximum soldering temperature should be limited to 260°
2. 当产品在处在高温状态中时不要对其硅胶施加压力。
Don't cause stress to the silicone resin while it is exposed to high temperature.
3. 回流焊的次数应小于两次。
Number of reflow process shall be 1 time.



LA-2835WWWWWWWWW

● 产品使用注意事项：(Handling Precautions)

◇ 测试电路：(Test circuit)

➢ 防止超过额定电流：(Over-current-proof)

用户必需加串电阻保护，否则有轻微的电压变化，将造成很大的电流变化（产品会被烧毁）。
Customer must apply resistors for protection; otherwise slight voltage shift will cause big current change(Burn out will happen).

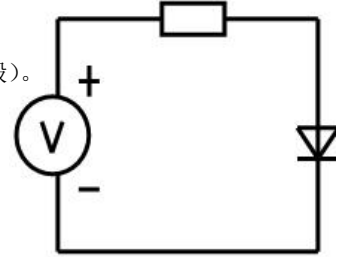

◇ 采用恒流电源：(The constant current power supply:)

➢ 建议用户采用恒流源驱动测试 LED。

Users are suggested the constant current source driver testing led.

◇ SMT 吸嘴选取：(How to choose the collet)

➢ 吸嘴设置不当产生的异常：(Abnormal situation caused by improper setting of collet)

选取合适的吸嘴是提高产品品质的关键所在，因 LED 与其它电子元件不同，它所承担的不只是电性的输出还有光学部份的输出，因此特性就决定了 LED 的命运在 SMT 过程中变的比较脆弱。若机器吸嘴下压高度设置的不当，即当吸嘴在吸起和放下材料的时候都有可能造成对 LED 的不亮或闪烁及品质问题。

To choose the right collet is the key issue in improving the product's quality. LED is different from other electronic components, which is not only about electrical output but also for optical output. This If the collet's lowering down height is not well set, it will bring damage to the gold wire at the time of collet's picking up and loaing which will cause the LED fail to light up, light up now and then or other quality problems.

➢ 吸嘴的选取：(How to choose the collet)

客户在 SMT 时直径尽量选择比 LED（胶体）发光面大的吸嘴防止吸嘴下压高度设置的不当造成对 LED 内部金线的损坏。根据不同产品吸嘴选取如下图：

During SMT, please choose the collet that has larger outer diameter than the lighting area of lens, in case that improper position of collet will damage the gold wire inside the LED. Different collets fit for different products, please refer to the following pictures cross out:

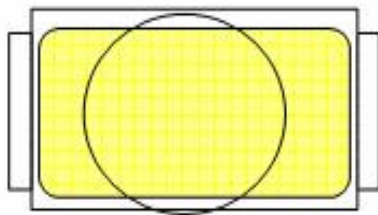

正确的吸嘴直径

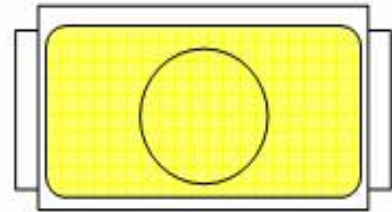

不正确的吸嘴直径

➢ 吸嘴高度设置：(How to set the height of collet)

在正面发光二极管 SMT 时吸嘴下压高度是引响 LED 品质的直接因素，因吸嘴下压太深会压迫 LED 胶体导致内部金线变形或断裂，造成 LED 不亮或闪烁；LED 的焊盘同 PCB 焊盘刚好接触最好，吸嘴高度设置如下图：

The reason why for top view SMD, the height of collet before it presses downward will directly affect the quality of products during SMT is that if the collect go down too much, it will press lens and cause the distortion or breaking of gold wire. The setting of collet position should follow the pictures bello



LA-2835WWWWWWWWW

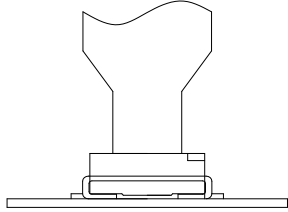

正确

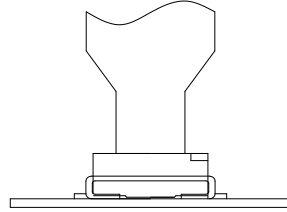

错误

◇ 其它注意事项: (Other points for attention:)

- 1、当 SMD LED 暴露在高温状态下时, 请注意不要按压其胶体部分。
No pressure should be exerted to the epoxy shell of the SMD under high temperature.
- 2、注意不要使用硬物和带尖锐边的物体刮、擦 SMD LED 的胶部分。
Do not scratch or wipe the lens since the lens and gold wire inside are rather fragile and cross out easy to break.
- 3、在下次使用前重复前面的除湿动作, 用于手动作业的散装 LED 使用前必须除湿。
LED should be used as soon as possible when being taken out of the original package, and should be stored in anti-moisture and anti-ESD package.
4. 不可将模组材料堆积在一起, 它可能会损坏内部电路
Do not stack together assembled PCBs containing LEDs. Impact may scratch the silicone lens or damage the internal circuitry

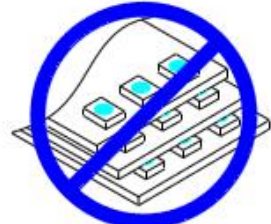
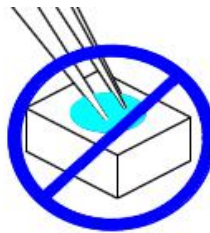
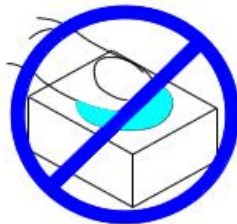

◇ 储藏 : (Storage)

1. 建议把产品储藏于以下的条件: 相对湿度: 60% (最大) 温度: 5°C~30°C (41°F~86°F)
It is recommended to store the products in the following conditions: Humidity: 60% R.H. Max.
Temperature : 5~30 (41~86)
2. 在封装袋内的保质期: 在 <5°C~30°C 和 <30%R.H (相对温度) 的条件下 12 月, 打开包装后, 产品需在一个星期内使用, 或者储存于相对湿度 ≤ 20%R.H 的密封包装中。
Shelf life in sealed bag: 12 month at 5~30 and 60% R.H. after the package is Opened, the products should be used within a week or they should be keeping to stored at 20 R.H. with zip-lock sealed.

◇ 烘烤: (Baking)

- 包装打开 12 小时后建议在焊接之前对产品进行烘烤, 条件如下:
It is recommended to baking before soldering when the pack is unsealed after 12hrs. The Conditions are as followings:
1. 贴片产品: 70±3°C (12~24 小时) 和 <5%,
70±3°C (12~24hrs) and 5%RH, taped reel type
 2. 散装产品: 100±3°C (1 小时)。
100±3°C 1hrs , bulk type



LA-2835WWWWWWWWW

其它注意事项: (Other points for attention)

- 1. LED 是静电敏感器件, 使用时所有设备、机构都需有适当的接地导电措施。
The LED is an ESD sensitive device. All the equipment and machine must be properly grounded.
- 2. 使用时请使用防静电的盛装容器, 作业人员应穿着防静电服装及佩戴有绳之静电环并作有效接地。
When make use of it, please use static-free container, operator should wear antistatic clothes and rope-static-ring also should make effective ground
- 3. 受静电与突波破坏之 LED 的电性特性上, 会有明显的漏电流, 或驱动电压明显变低, 甚至是短路现象。
Damaged device will appear some symptoms, lower forward voltage, higher leak current, or even short current.
- 4. 上在焊接温度回到正常以前, 必须避免使 LED 受到任何震动或外力。
After soldering the LED should keep out off any shake or outer force before it come to normal temperature
- 5. LED 不宜过两次回流焊接, 在高温焊接期间, 不要在 LED 表面施压。LED 焊接后, 不要弯曲线路板。LED 焊接后不宜进行返修, 当返修不可避免时, 请事先确认返修是否使 LED 的特性受到破坏, 再确定是否使用烙铁进行返修。
Reflow soldering should not be done more than two times, when soldering, do not put stress on the LEDs during heating. After soldering, do not warp the circuit board. Repair should not be done after the LEDs have been soldered. When repairing is unavoidable, a double-head soldering iron should be used. It should be confirmed before hand whether the characteristics of the LEDs will not be damaged by repairing.
- 6. LED 单向导通性, 安装前确认极性, 若装反, 在施加电压时容易造成 LED 芯片损伤或失效
LED is one-way continuity, please check electrode before mount, if mount wrong, the LED chip will damage or fail when LED applied voltage.
- 7. 线路设计时, 请尽量避免将 LED 与发热组件靠得过近。
Please design the PCB board to keep a distance between LED and other emit heat component.
- 8. 电路设计上, 建议以定电流设计, 若为定电压设计, 请考虑 LED 之间不同正向电压所可能造成之影响。
Strongly recommend design the board according setting current other than setting voltage. if you are really need setting voltage type please consider there may cause influence arise by difference voltage of difference LED.
- 9. LED 之外加电压变化, 会造成电流指数级变化, 不当之设计与电流控制, 易造成 LED 失效, 如电流过大引起寿命问题甚至 LED 烧毁, 电流过小引起亮度不足。
The outer voltage change will bring the current index change. unsuitable design and current control, easy cause LED fail. for example excess current will cause LED life short or even burn down, too little electricity will cause lacking light.
- 10. 不同 BIN 号之 LED 需安装在同一个组件时, 请先确认是否可满足相关电气及光学之特性要求, 如电流是否均衡, 光色、亮度一致性等。
If you need make difference BIN LED in the one module. please confirm whether it can meet the electric and optics characteristic require such as the current balance, emitting and brightness consistency